

RoHS Compliant Product  
A suffix of "-C" specifies halogen & lead-free

## DESCRIPTION

The SSESD03 is designed to protect voltage-sensitive components from ESD. Excellent clamping capability, low leakage, and fast response time provide best in class protection on designs that are exposed to ESD. Because of its small size, it is suited for use in cellular phones, MP3 players, digital cameras and many other portable applications where board space is at a premium.

SOD-923

## APPLICATIONS

- Cellular phones / audio
- Portable devices
- Digital cameras
- MP3 players

## FEATURES

- Small Body Outline Dimensions:  
0.039" x 0.024" (1.0 mm x 0.60 mm)
- Low Body Height: 0.017" (0.43 mm) Max
- Stand-off Voltage: 3.3 V
- Low Leakage Current
- Response Time is typically < 1 ns
- ESD Rating of Class 3 (> 16 kV)  
per Human Body Model
- IEC61000-4-2 Level 4 ESD Protection
- These are Pb-Free Devices

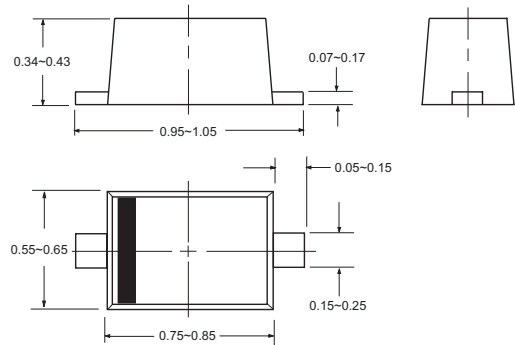

Dimensions in millimeters

- The marking band indicates cathode.

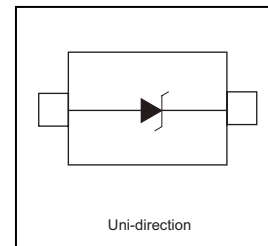

## ABSOLUTE RATINGS (T<sub>amb</sub> = 25°C)

Rating	Symbol	Value	Units
IEC 61000-4-2 (ESD)	Air contact	±15	kV
	Contact discharge	±8	kV
ESD voltage	Per human body model	16	kV
Total power dissipation on FR-5 Board (Note 1) @ T <sub>A</sub> =25°C	P <sub>D</sub>	150	mW
Junction and storage temperature range	T <sub>J</sub> , T <sub>STG</sub>	-55 ~ +150	°C
Lead solder temperature – maximum (10 Second duration)	T <sub>L</sub>	260	°C

Stresses exceeding Maximum Ratings may damage the device. Maximum Rating are stress ratings only. Functional operation above the Recommended Operating Conditions is not implied. Extended exposure to stresses above the Recommended Operating Conditions may affect device reliability.

1. FR-5 = 1.0\*0.75\*0.62 in.

## ELECTRICAL CHARACTERISTICS

(Ratings at 25°C ambient temperature unless otherwise specified. V<sub>F</sub> = 0.9V at I<sub>F</sub> = 10mA)

Device	V <sub>RWM</sub> (V)	I <sub>R</sub> (uA) @ V <sub>RWM</sub>	V <sub>BR</sub> (V) @ I <sub>T</sub> (Note 2)	I <sub>T</sub> (mA)	V <sub>C</sub> (V) @ Max I <sub>PP</sub> (Note 3)	I <sub>PP</sub> (A) (Note 3)	P <sub>PK</sub> (W)*	C (pF)
	Max	Max	Min	mA	Max	Max	Max	Typ
SSESD03	3.3	2.5	5.0	1.0	10.4	9.8	102	80

Other voltages available upon request.

2. V<sub>BR</sub> is measured with a pulse test current I<sub>T</sub> at an ambient temperature of 25°C

3. Surge current waveform per Figure 3.

**RATINGS AND CHARACTERISTICS CURVES**

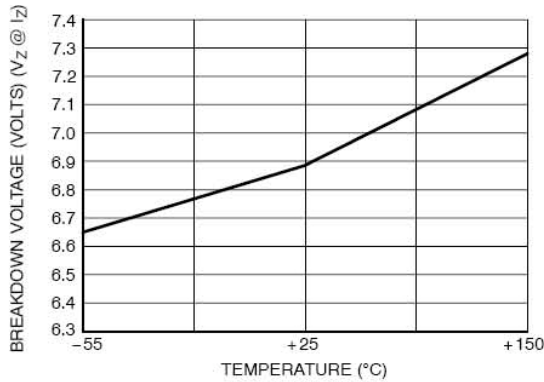

**Figure 1. Typical Breakdown Voltage versus Temperature**

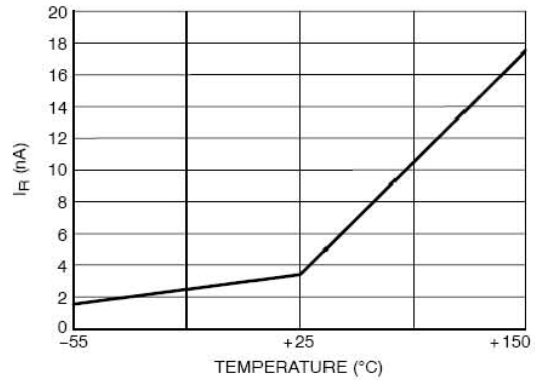

**Fig 2. Typical Leakage Current versus Temperature**

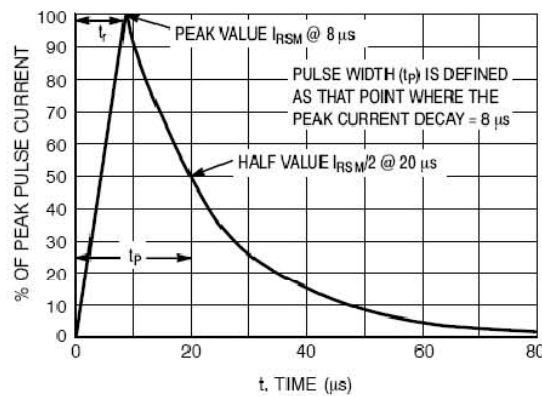

**Figure 3. 8\*20  $\mu s$  Pulse Waveform**

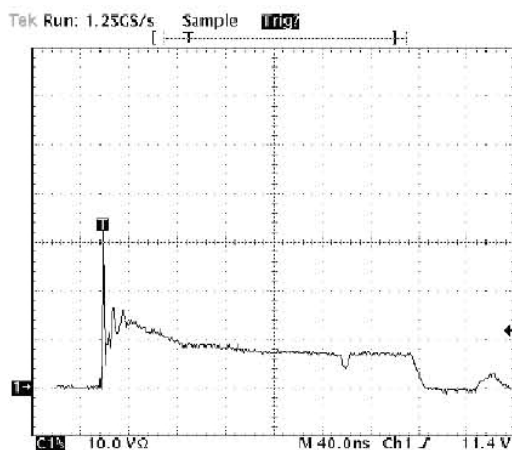

**Figure 4. Positive 8kV contact per IEC 61000-4-2-SSESD05**

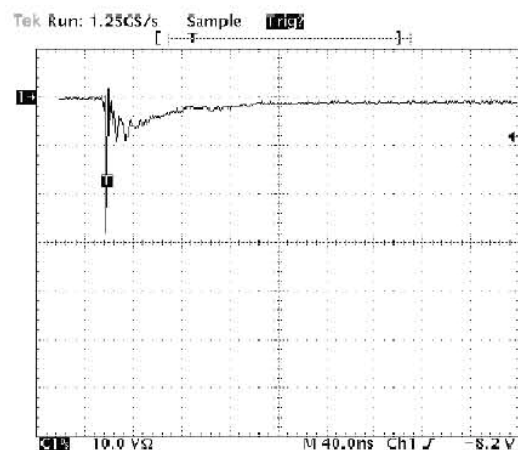

**Fig 5. Negative 8kV contact per IEC 61000-4-2-SSESD05**