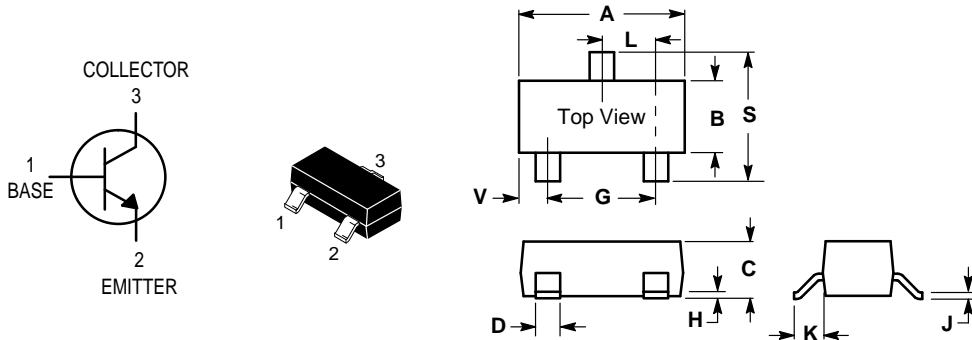


RoHS Compliant Product



SOT-323		
Dim	Min	Max
A	1.800	2.200
B	1.150	1.350
C	0.800	1.000
D	0.300	0.400
G	1.200	1.400
H	0.000	0.100
J	0.100	0.250
K	0.350	0.500
L	0.590	0.720
S	2.000	2.400
V	0.280	0.420
All Dimension in mm		

**MAXIMUM RATINGS**

Rating	Symbol	Value	Unit
Collector–Emitter Voltage	$V_{CEO}$	40	Vdc
Collector–Base Voltage	$V_{CBO}$	60	Vdc
Emitter–Base Voltage	$V_{EBO}$	6.0	Vdc
Collector Current — Continuous	$I_C$	600	mAdc

**THERMAL CHARACTERISTICS**

Characteristic	Symbol	Max	Unit
Total Device Dissipation FR–5 Board <sup>(1)</sup> $T_A = 25^\circ\text{C}$ Derate above $25^\circ\text{C}$	$P_D$	200 1.8	mW mW/°C
Thermal Resistance, Junction to Ambient	$R_{\theta JA}$	556	°C/W
Total Device Dissipation Alumina Substrate, <sup>(2)</sup> $T_A = 25^\circ\text{C}$ Derate above $25^\circ\text{C}$	$P_D$	200 2.4	mW mW/°C
Thermal Resistance, Junction to Ambient	$R_{\theta JA}$	417	°C/W
Junction and Storage Temperature	$T_J, T_{stg}$	-55 to +150	°C

**DEVICE MARKING**

MMBT4401W = K3X, 2X
---------------------

**ELECTRICAL CHARACTERISTICS** ( $T_A = 25^\circ\text{C}$  unless otherwise noted)

Characteristic	Symbol	Min	Max	Unit
----------------	--------	-----	-----	------

**OFF CHARACTERISTICS**

Collector–Emitter Breakdown Voltage <sup>(3)</sup> ( $I_C = 1.0 \text{ mAdc}, I_B = 0$ )	$V_{(BR)CEO}$	40	—	Vdc
Collector–Base Breakdown Voltage ( $I_C = 0.1 \text{ mAdc}, I_E = 0$ )	$V_{(BR)CBO}$	60	—	Vdc
Emitter–Base Breakdown Voltage ( $I_E = 0.1 \text{ mAdc}, I_C = 0$ )	$V_{(BR)EBO}$	6.0	—	Vdc
Base Cutoff Current ( $V_{CE} = 35 \text{ Vdc}, V_{EB} = 0.4 \text{ Vdc}$ )	$I_{BEV}$	—	0.1	$\mu\text{Adc}$
Collector Cutoff Current ( $V_{CE} = 35 \text{ Vdc}, V_{EB} = 0.4 \text{ Vdc}$ )	$I_{CEX}$	—	0.1	$\mu\text{Adc}$

- FR–5 =  $1.0 \times 0.75 \times 0.062 \text{ in.}$
- Alumina =  $0.4 \times 0.3 \times 0.024 \text{ in.}$  99.5% alumina.
- Pulse Test: Pulse Width  $\leq 300 \mu\text{s}$ , Duty Cycle  $\leq 2.0\%$ .

**ELECTRICAL CHARACTERISTICS** (continued) ( $T_A = 25^\circ\text{C}$  unless otherwise noted)

Characteristic	Symbol	Min	Max	Unit
<b>ON CHARACTERISTICS(3)</b>				
DC Current Gain ( $I_C = 0.1 \text{ mA}$ , $V_{CE} = 1.0 \text{ Vdc}$ ) ( $I_C = 1.0 \text{ mA}$ , $V_{CE} = 1.0 \text{ Vdc}$ ) ( $I_C = 10 \text{ mA}$ , $V_{CE} = 1.0 \text{ Vdc}$ ) ( $I_C = 150 \text{ mA}$ , $V_{CE} = 1.0 \text{ Vdc}$ ) ( $I_C = 500 \text{ mA}$ , $V_{CE} = 2.0 \text{ Vdc}$ )	$h_{FE}$	20 40 80 100 40	— — — 300 —	—
Collector–Emitter Saturation Voltage ( $I_C = 150 \text{ mA}$ , $I_B = 15 \text{ mA}$ ) ( $I_C = 500 \text{ mA}$ , $I_B = 50 \text{ mA}$ )	$V_{CE(sat)}$	— —	0.4 0.75	Vdc
Base–Emitter Saturation Voltage ( $I_C = 150 \text{ mA}$ , $I_B = 15 \text{ mA}$ ) ( $I_C = 500 \text{ mA}$ , $I_B = 50 \text{ mA}$ )	$V_{BE(sat)}$	0.75 —	0.95 1.2	Vdc

**SMALL–SIGNAL CHARACTERISTICS**

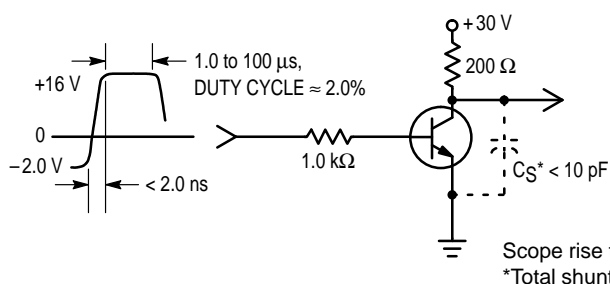
Current–Gain — Bandwidth Product ( $I_C = 20 \text{ mA}$ , $V_{CE} = 10 \text{ Vdc}$ , $f = 100 \text{ MHz}$ )	$f_T$	250	—	MHz
Collector–Base Capacitance ( $V_{CB} = 5.0 \text{ Vdc}$ , $I_E = 0$ , $f = 1.0 \text{ MHz}$ )	$C_{cb}$	—	6.5	pF
Emitter–Base Capacitance ( $V_{EB} = 0.5 \text{ Vdc}$ , $I_C = 0$ , $f = 1.0 \text{ MHz}$ )	$C_{eb}$	—	30	pF
Input Impedance ( $I_C = 1.0 \text{ mA}$ , $V_{CE} = 10 \text{ Vdc}$ , $f = 1.0 \text{ kHz}$ )	$h_{ie}$	1.0	15	k $\Omega$
Voltage Feedback Ratio ( $I_C = 1.0 \text{ mA}$ , $V_{CE} = 10 \text{ Vdc}$ , $f = 1.0 \text{ kHz}$ )	$h_{re}$	0.1	8.0	$\times 10^{-4}$
Small–Signal Current Gain ( $I_C = 1.0 \text{ mA}$ , $V_{CE} = 10 \text{ Vdc}$ , $f = 1.0 \text{ kHz}$ )	$h_{fe}$	40	500	—
Output Admittance ( $I_C = 1.0 \text{ mA}$ , $V_{CE} = 10 \text{ Vdc}$ , $f = 1.0 \text{ kHz}$ )	$h_{oe}$	1.0	30	$\mu\text{mhos}$

**SWITCHING CHARACTERISTICS**

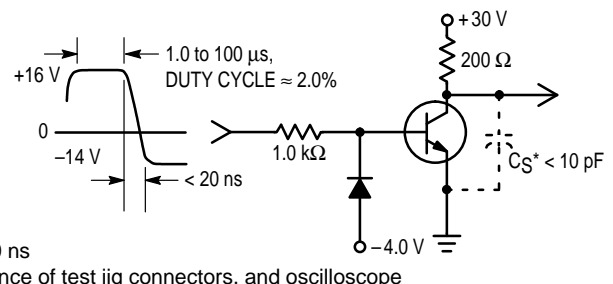
Delay Time	( $V_{CC} = 30 \text{ Vdc}$ , $V_{EB} = 2.0 \text{ Vdc}$ , $I_C = 150 \text{ mA}$ , $I_{B1} = 15 \text{ mA}$ )	$t_d$	—	15	ns
Rise Time		$t_r$	—	20	
Storage Time	( $V_{CC} = 30 \text{ Vdc}$ , $I_C = 150 \text{ mA}$ , $I_{B1} = I_{B2} = 15 \text{ mA}$ )	$t_s$	—	225	ns
Fall Time		$t_f$	—	30	

3. Pulse Test: Pulse Width  $\leq 300 \mu\text{s}$ , Duty Cycle  $\leq 2.0\%$ .

**SWITCHING TIME EQUIVALENT TEST CIRCUITS**



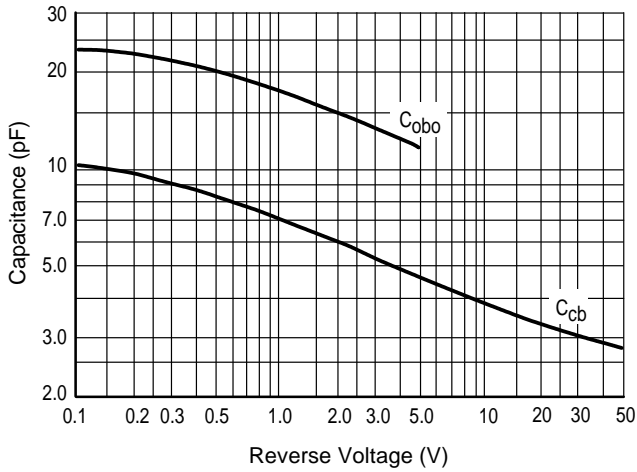
**Figure 1. Turn–On Time**



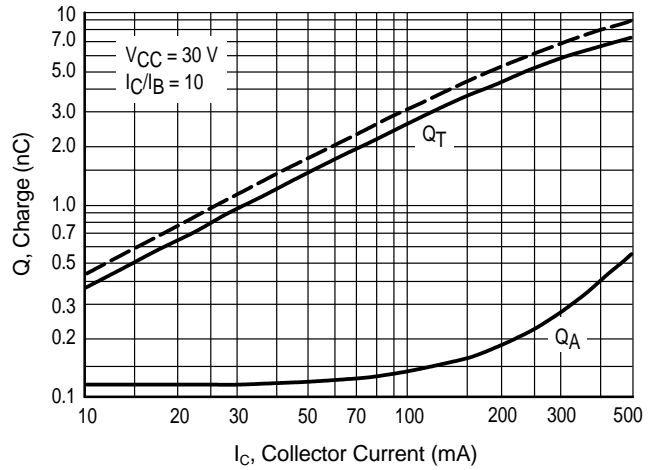
**Figure 2. Turn–Off Time**

**TRANSIENT CHARACTERISTICS**

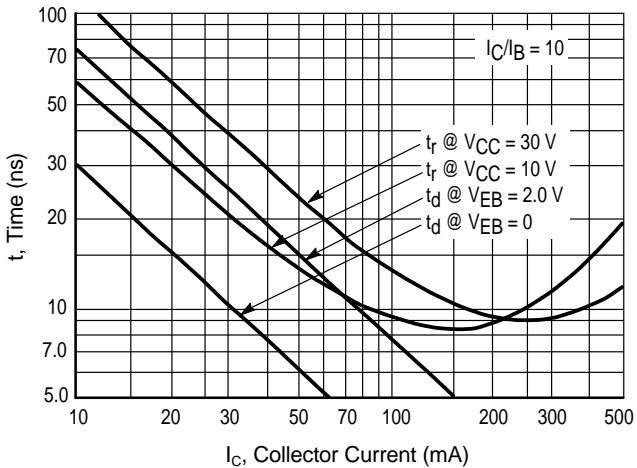
— 25°C    - - - 100°C



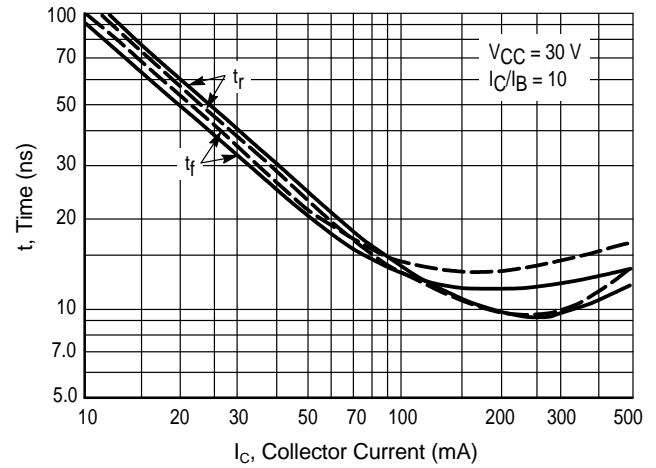
**Figure 3. Capacitances**



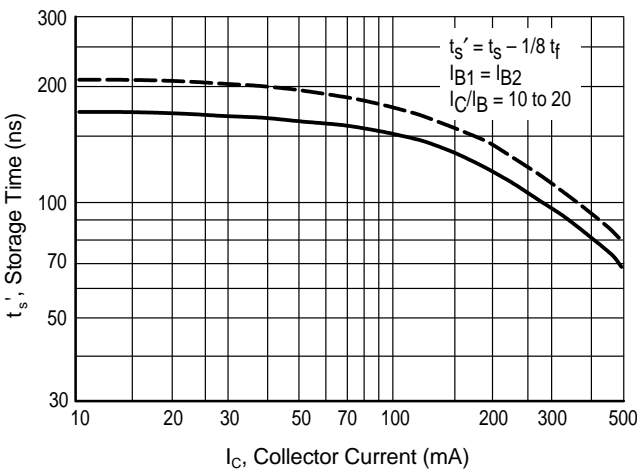
**Figure 4. Charge Data**



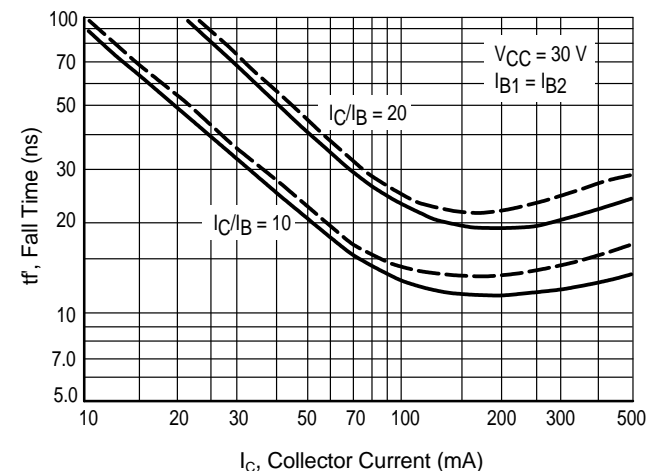
**Figure 5. Turn-On Time**



**Figure 6. Rise and Fall Times**



**Figure 7. Storage Time**

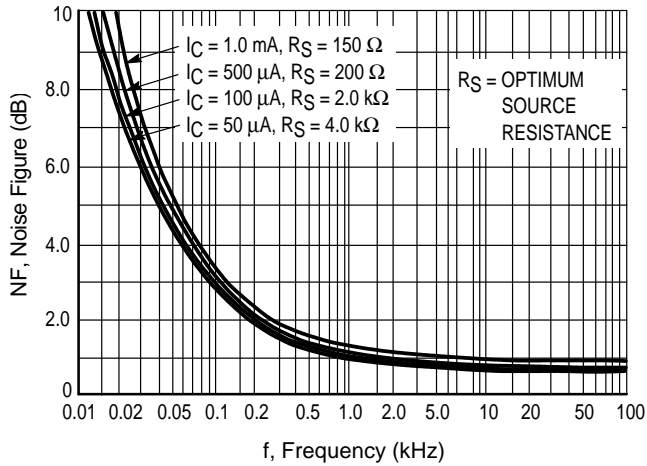


**Figure 8. Fall Time**

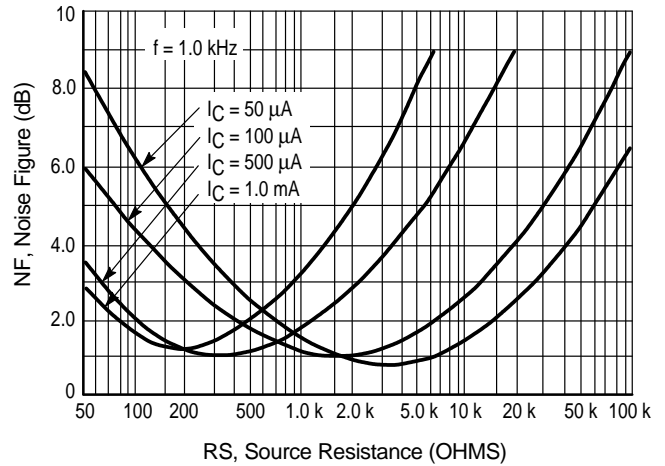
**SMALL-SIGNAL CHARACTERISTICS**

**NOISE FIGURE**

$V_{CE} = 10 \text{ Vdc}$ ,  $T_A = 25^\circ\text{C}$   
Bandwidth = 1.0 Hz



**Figure 9. Frequency Effects**



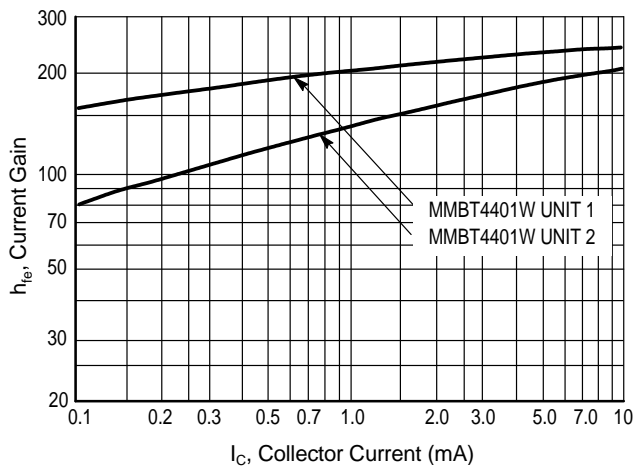
**Figure 10. Source Resistance Effects**

**h PARAMETERS**

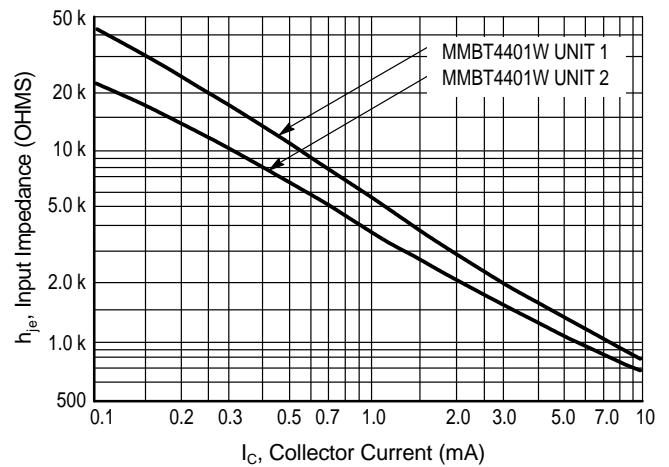
$V_{CE} = 10 \text{ Vdc}$ ,  $f = 1.0 \text{ kHz}$ ,  $T_A = 25^\circ\text{C}$

This group of graphs illustrates the relationship between  $h_{fe}$  and other "h" parameters for this series of transistors. To obtain these curves, a high-gain and a low-gain unit were

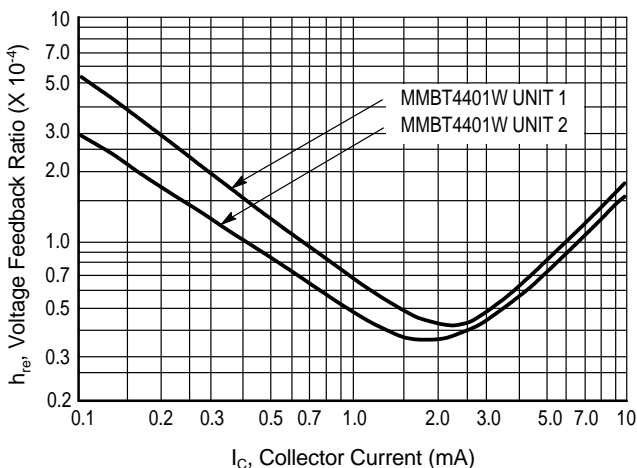
selected from the MMBT4401W lines, and the same units were used to develop the correspondingly numbered curves on each graph.



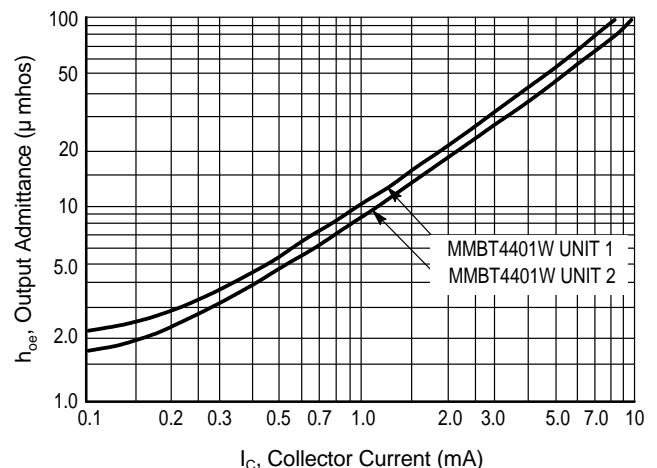
**Figure 11. Current Gain**



**Figure 12. Input Impedance**

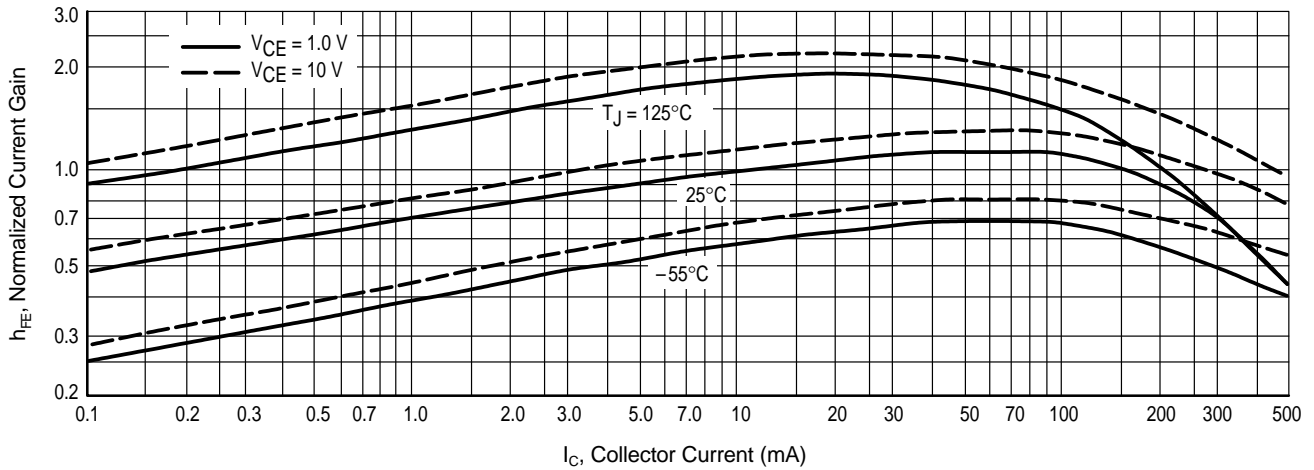


**Figure 13. Voltage Feedback Ratio**

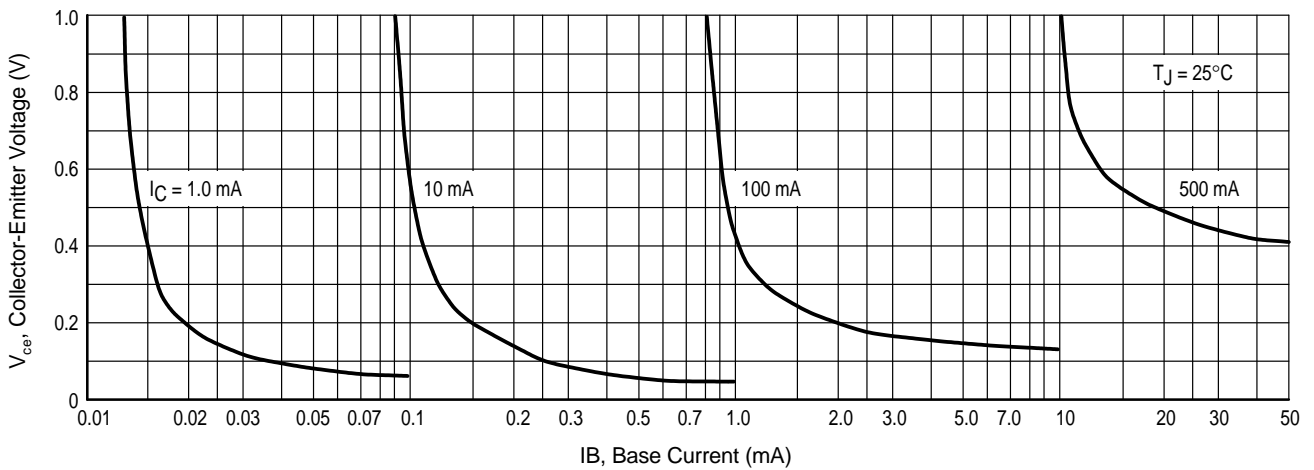


**Figure 14. Output Admittance**

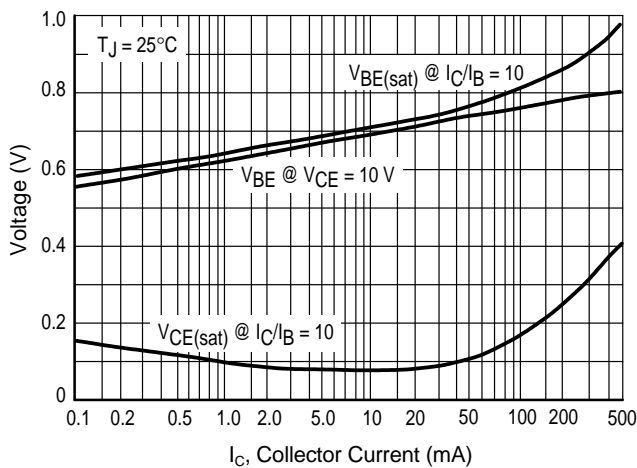
**STATIC CHARACTERISTICS**



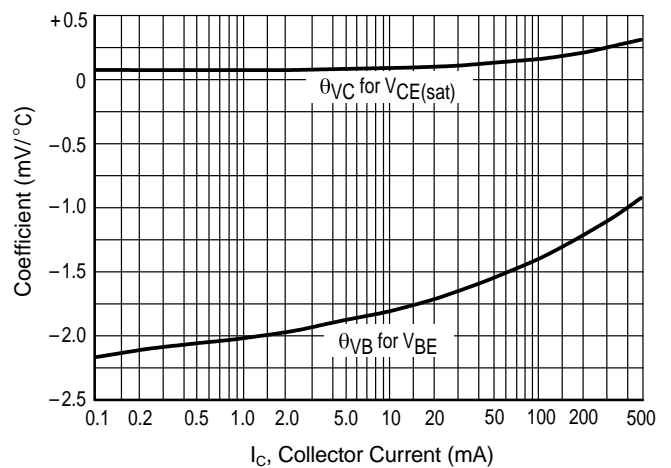
**Figure 15. DC Current Gain**



**Figure 16. Collector Saturation Region**



**Figure 17. "On" Voltages**



**Figure 18. Temperature Coefficients**