

RoHS compliant product
A suffix of "-C" specifies halogen free

FEATURES

- Zero Reverse Recovery Current
- Zero Forward Recovery Voltage
- Positive Temperature Coefficient on V_F
- Temperature-independent Switching
- 175°C Operating Junction Temperature

TO-263(D²-PACK)

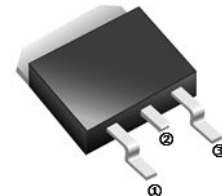

MECHANICAL DATA

- Case: Molded Plastic
- Epoxy: UL94V-0 Rate Flame Retardant
- Lead: Lead Solderable per MIL-STD-202 Method 208 Guaranteed
- Polarity: As Marked
- Mounting Position: Any

APPLICATIONS

- Switch Mode Power Supplies
- Power Factor Correction
- Motor Drive, PV Inverter, Wind Power Station

ORDER INFORMATION

Part Number	Type
SIC20X120DS-C	Lead (Pb)-free and Halogen-free

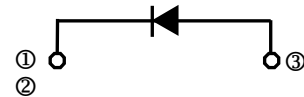

MAXIMUM RATINGS (Rating 25°C Case temperature unless otherwise)

Parameter	Symbol	Rating	Unit
Repetitive Peak Reverse Voltage	V_{RRM}	1200	V
Surge Peak Reverse Voltage	V_{RSM}	1200	V
DC Blocking Voltage	V_{DC}	1200	V
Forward Current	I_F	$T_C \leq 25^\circ\text{C}$	51
		$T_C \leq 135^\circ\text{C}$	24
		$T_C \leq 146^\circ\text{C}$	20
Peak Forward Surge Current @8.3ms half sine-wave	I_{FSM}	180	A
Power Dissipation	$T_C = 25^\circ\text{C}$	P_D	230
Operating Junction & Storage Temperature	T_J, T_{STG}	-55~175	°C
Thermal Resistance Ratings			
Typical Thermal Resistance Junction-Ambient	$R_{\theta JA}$	80	°C/W
Typical Thermal Resistance Junction-Case	$R_{\theta JC}$	0.65	

ELECTRICAL CHARACTERISTICS

Parameter	Symbol	Typ.	Max.	Unit	Test Conditions
Forward Voltage	V_F	1.55	1.8	V	$I_F=20A, T_J=25^\circ C$
		2.2	2.5		$I_F=20A, T_J=175^\circ C$
Reverse Current	I_R	5	20	μA	$V_R=1200V, T_J=25^\circ C$
		30	200		$V_R=1200V, T_J=175^\circ C$
Junction Capacitance	C_J	1280	-	pF	$V_R=0V, T_J=25^\circ C, f=1MHz$
		95	-		$V_R=400V, T_J=25^\circ C, f=1MHz$
		77	-		$V_R=800V, T_J=25^\circ C, f=1MHz$
Total Capacitive Charge	Q_C	51	-	nC	$V_R=800V, I_F=20A, T_J=25^\circ C, di/dt=200A/\mu s$

CHARACTERISTIC CURVES

Typical Forward Current Derating Curve

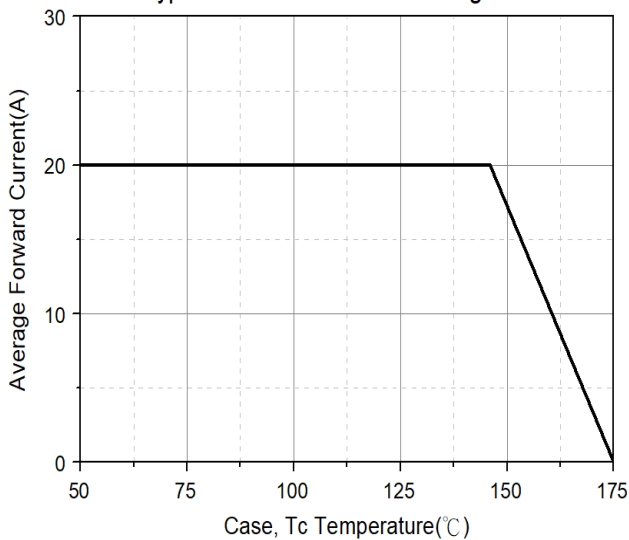

Power Derating

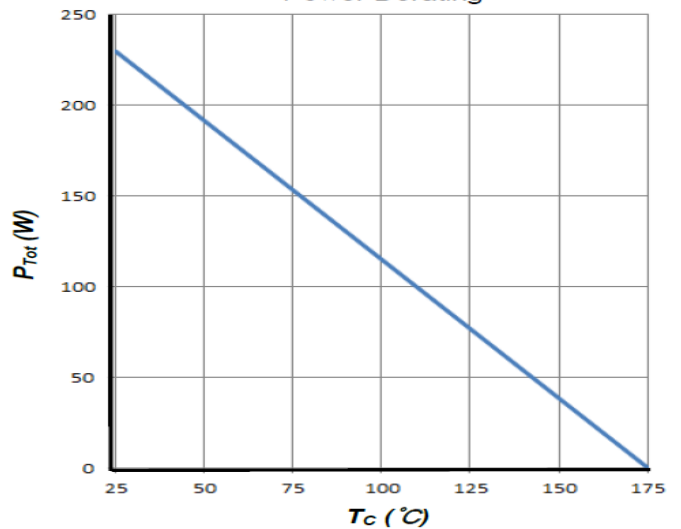

Forward Characteristics

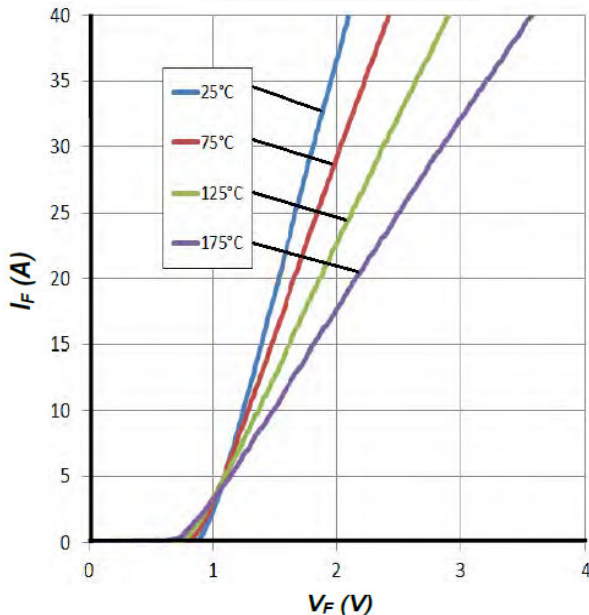

Reverse Characteristics

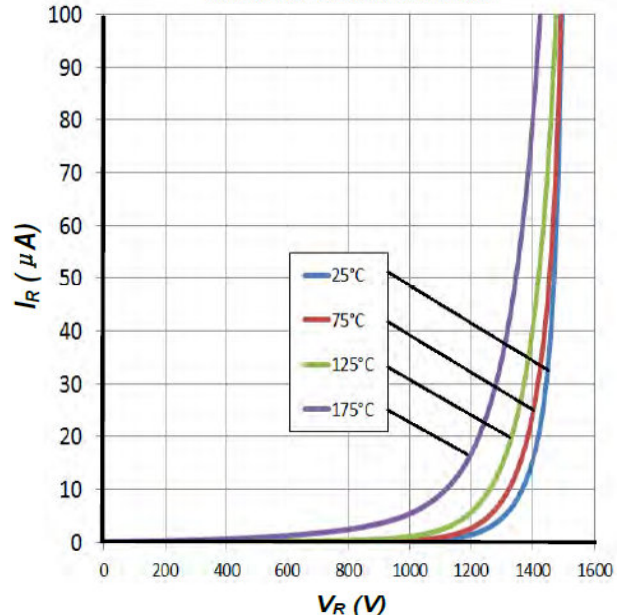

CHARACTERISTIC CURVES

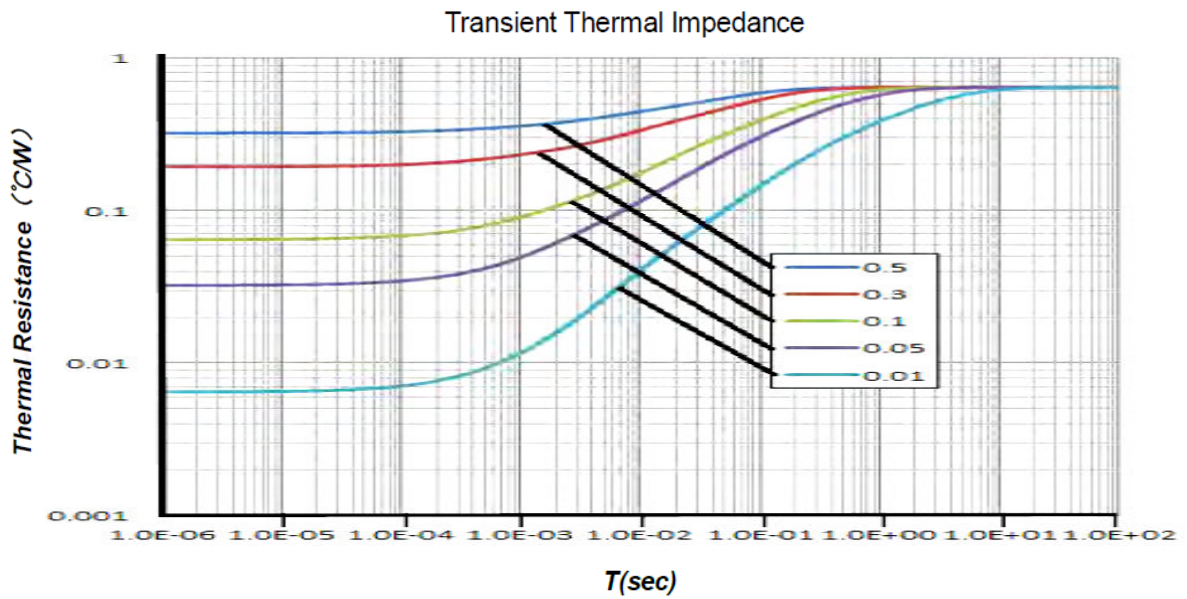
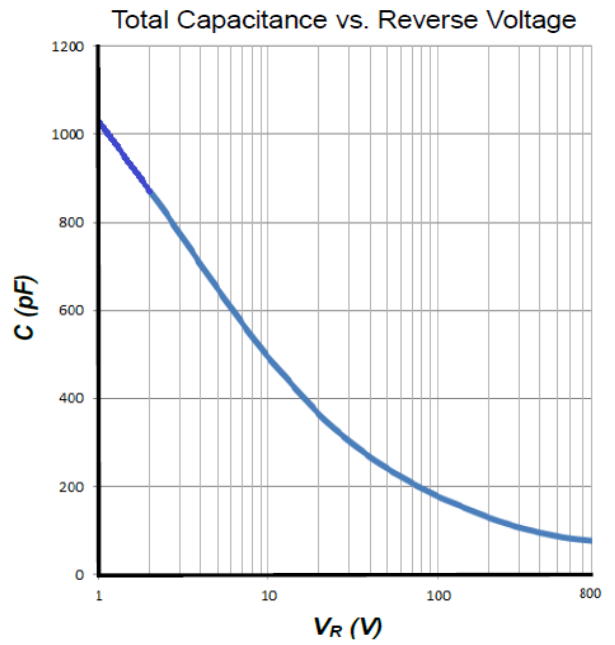
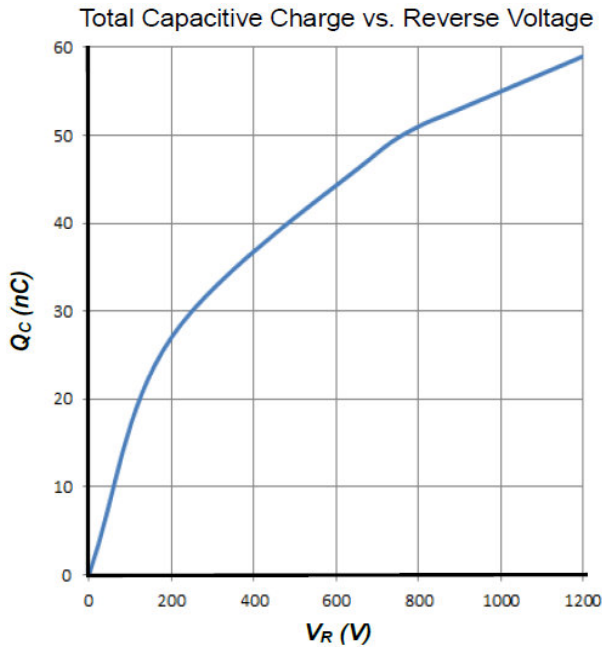

PACKAGE OUTLINE DIMENSIONS

TO-263

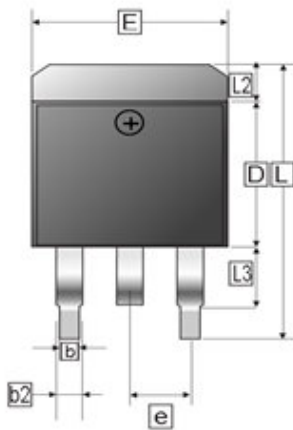

REF.	Millimeter	
	Min.	Max.
A	4.00	4.87
b	0.508	1.01
L4	0	0.30
C	0.30	0.74
L3	1.50 REF.	
L1	2.50 REF.	
E	9.60	10.67
c2	1.07	1.65
b2	1.34 REF.	
D	8.00	9.652
e	2.54 REF.	
L	14.6	16.1
L2	1.27 REF.	

MOUNTING PAD LAYOUT

TO-263

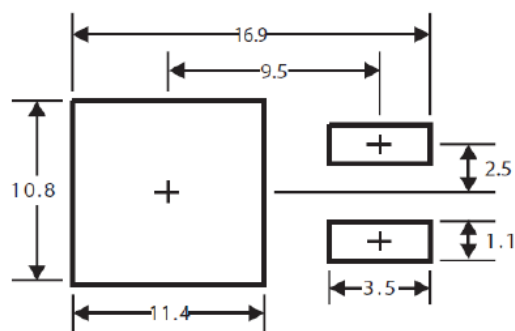

*Dimensions in millimeters