

RoHS Compliant Product  
A suffix of "-C" specifies halogen & lead-free

## DESCRIPTION

The SMS8810-C provide the designer with the best combination of fast switching, ruggedized device design, low on-resistance and cost-effectiveness. The SOT-23 package is universally preferred for all commercial-industrial surface mount applications and suited for low voltage applications such as DC/DC converters.

SOT-23

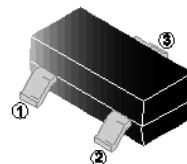

## FEATURES

- Lower Gate Charge
- Simple Drive Requirement
- Fast Switching Characteristic

## MARKING

8810

## PACKAGE INFORMATION

Package	MPQ	Leader Size
SOT-23	3K	7 inch

## ORDER INFORMATION

Part Number	Type
SMS8810-C	Lead (Pb)-free and Halogen-free

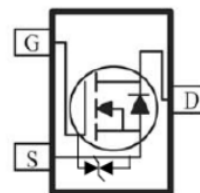

## ABSOLUTE MAXIMUM RATINGS (T<sub>A</sub>=25°C unless otherwise specified)

Parameter	Symbol	Rating	Unit
Drain-Source Voltage	V <sub>DS</sub>	20	V
Gate-Source Voltage	V <sub>GS</sub>	±12	V
Continuous Drain Current	I <sub>D</sub>	7	A
Pulsed Drain Current <sup>1</sup>	I <sub>DM</sub>	30	A
Thermal Resistance Junction-Ambient	R <sub>θJA</sub>	417	°C / W
Operating Junction & Storage Temperature	T <sub>J</sub> , T <sub>STG</sub>	-55~150	°C
Lead Temperature for Soldering Purposes (1/8" from case for 10 s)	T <sub>L</sub>	260	°C

Note:

1. Repetitive rating : Pulse width limited by junction temperature.

**ELECTRICAL CHARACTERISTICS** ( $T_A=25^\circ\text{C}$  unless otherwise specified)

Parameter	Symbol	Min.	Typ.	Max.	Unit	Test Conditions
Drain-Source Breakdown Voltage	$BV_{DSS}$	20	-	-	V	$V_{GS}=0, I_D=250\mu\text{A}$
Gate-Threshold Voltage <sup>1</sup>	$V_{GS(th)}$	0.4	-	1	V	$V_{DS}=V_{GS}, I_D=250\mu\text{A}$
Gate-Source Leakage Current	$I_{GSS}$	-	-	$\pm 1$	$\mu\text{A}$	$V_{GS}=\pm 4.5\text{V}, V_{DS}=0$
		-	-	$\pm 10$		$V_{GS}=\pm 8\text{V}, V_{DS}=0$
Drain-Source Leakage Current	$I_{DSS}$	-	-	1	$\mu\text{A}$	$V_{DS}=16\text{V}, V_{GS}=0$
Static Drain-Source On-Resistance <sup>1</sup>	$R_{DS(ON)}$	-	-	20	m $\Omega$	$V_{GS}=10\text{V}, I_D=7\text{A}$
		-	-	22		$V_{GS}=4.5\text{V}, I_D=6.6\text{A}$
		-	-	24		$V_{GS}=3.8\text{V}, I_D=6\text{A}$
		-	-	26		$V_{GS}=2.5\text{V}, I_D=5.5\text{A}$
		-	-	35		$V_{GS}=1.8\text{V}, I_D=5\text{A}$
Forward Transconductance <sup>1</sup>	$g_{fs}$	9	-	-	S	$V_{DS}=5\text{V}, I_D=7\text{A}$
Total Gate Charge	$Q_g$	-	15	-	nC	$V_{GS}=4.5\text{V}$ $V_{DS}=10\text{V}$ $I_D=7\text{A}$
Gate-Source Charge	$Q_{gs}$	-	0.8	-		
Gate-Drain Charge	$Q_{gd}$	-	3.2	-		
Turn-on Delay Time	$T_{d(on)}$	-	6	-	nS	$V_{DD}=10\text{V}$ $V_{GEN}=5\text{V}$ $R_{GEN}=3\Omega$ $R_L=1.35\Omega$
Rise Time	$T_r$	-	13	-		
Turn-off Delay Time	$T_{d(off)}$	-	52	-		
Fall Time	$T_f$	-	16	-		
Input Capacitance	$C_{iss}$	-	1150	-	pF	$V_{GS}=0$ $V_{DS}=10\text{V}$ $f=1\text{MHz}$
Output Capacitance	$C_{oss}$	-	185	-		
Reverse Transfer Capacitance	$C_{rss}$	-	145	-		
<b>Source-Drain Diode</b>						
Diode Forward Voltage <sup>1</sup>	$V_{SD}$	-	-	1	V	$I_S=1\text{A}, V_{GS}=0$

Notes:

1. Pulse Test: Pulse Width  $\leq 300\mu\text{s}$ , Duty Cycle  $\leq 0.5\%$ .
2. Guaranteed by design, not subject to production testing.

**CHARACTERISTIC CURVES**

**Output Characteristics**

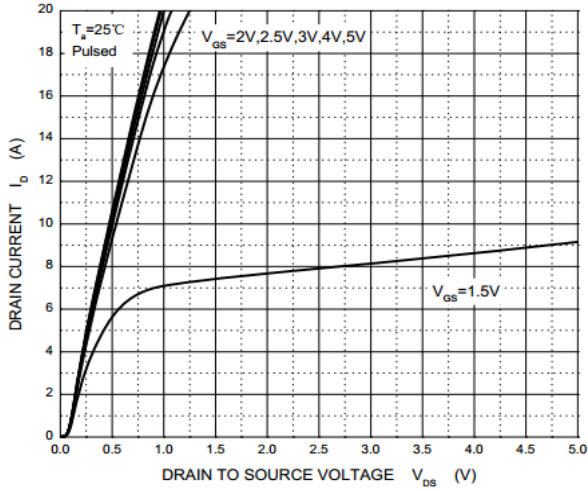

**Transfer Characteristics**

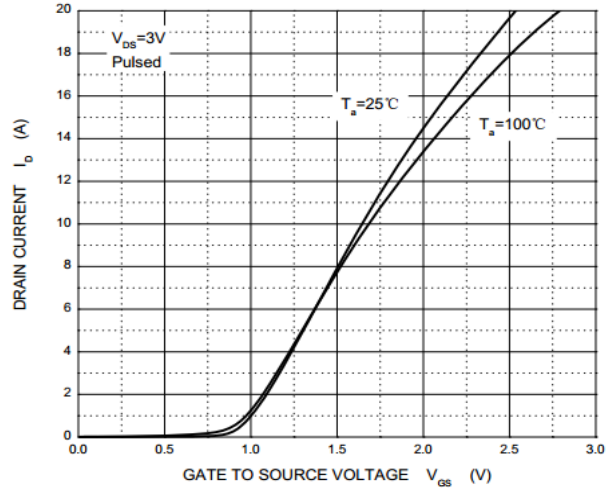

**$R_{DS(ON)}$  —  $I_D$**

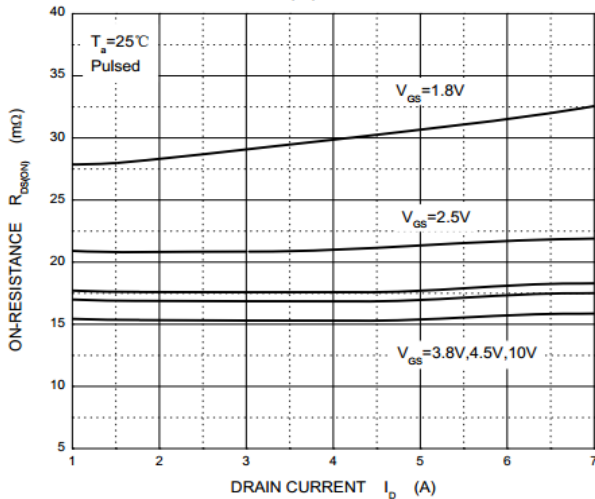

**$R_{DS(ON)}$  —  $V_{GS}$**

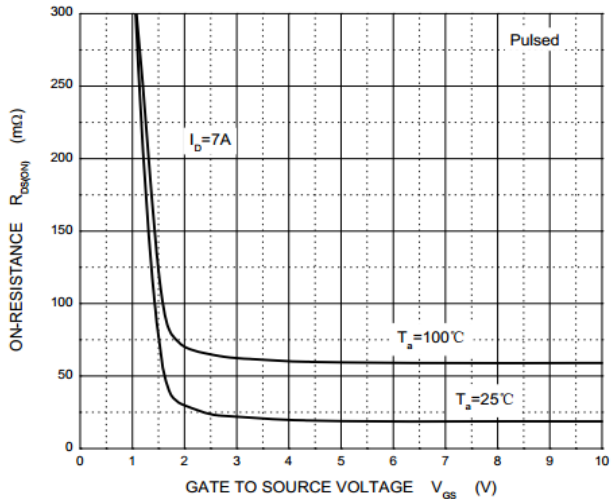

**$I_S$  —  $V_{SD}$**

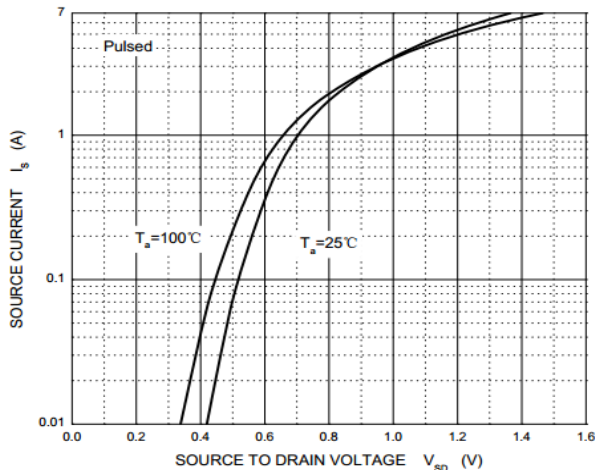

**Threshold Voltage**

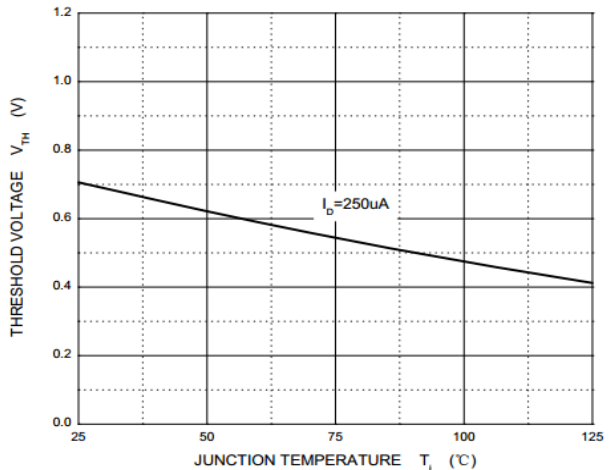

**PACKAGE OUTLINE DIMENSIONS**

**SOT-23**

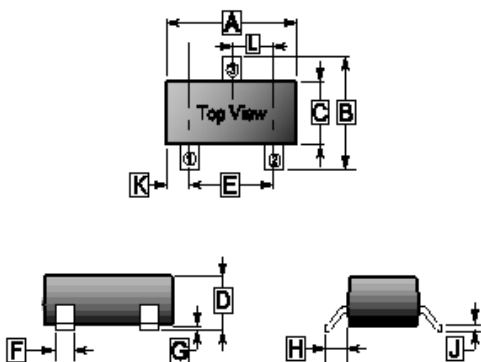

REF.	Millimeter	
	Min.	Max.
A	2.65	3.10
B	2.10	3.00
C	1.10	1.80
D	0.89	1.40
E	1.70	2.30
F	0.28	0.55
G	-	0.18
H	0.55 REF.	
J	0.05	0.26
K	0.60 REF.	
L	0.95 TYP.	

**MOUNTING PAD LAYOUT**

**SOT-23**

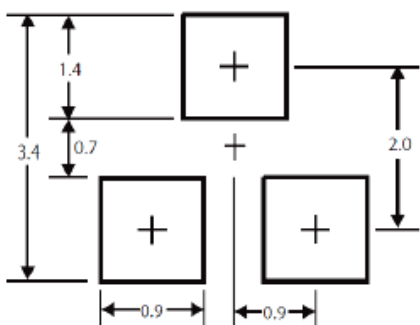

\*Dimensions in millimeters