

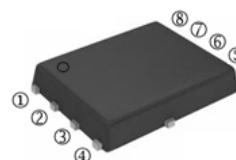
RoHS Compliant Product  
A suffix of "-C" specifies halogen & lead-free

## DESCRIPTION

The SPRD3110-C is the highest performance trench Dual N-ch MOSFETs with extreme high cell density, which provide excellent  $R_{DS(ON)}$  and gate charge for most of the synchronous buck converter applications.

The SPRD3110-C meet the RoHS and Green Product requirement with full function reliability approved.

**DFN5x6-8D**



## FEATURES

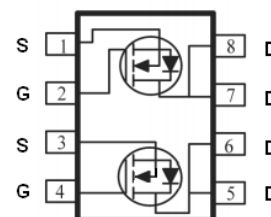
- Advanced High Cell Density Trench Technology
- Super Low Gate Charge
- Green Device Available

## MARKING



## PACKAGE INFORMATION

Package	MPQ	Leader Size
DFN5x6-8D	3K	13 inch



## ORDER INFORMATION

Part Number	Type
SPRD3110-C	Lead (Pb)-free and Halogen-free

## ABSOLUTE MAXIMUM RATINGS

Parameter	Symbol	Ratings	Unit
Drain-Source Voltage	$V_{DS}$	100	V
Gate-Source Voltage	$V_{GS}$	$\pm 20$	V
Continuous Drain Current <sup>1</sup> @ $V_{GS}=10V$	$I_D$	$T_C=25^\circ C$	5.5
		$T_C=100^\circ C$	3.5
Pulsed Drain Current <sup>3</sup>	$I_{DM}$	15	A
Total Power Dissipation <sup>1</sup>	$P_D$	$T_C=25^\circ C$	17
		$T_A=25^\circ C$	2
Operating Junction & Storage Temperature Range	$T_J, T_{STG}$	-55~150	$^\circ C$
<b>Thermal Data</b>			
Thermal Resistance Junction-Ambient <sup>1</sup>	$R_{\theta JA}$	62.5	$^\circ C/W$
Thermal Resistance Junction-Ambient <sup>2</sup>		110	
Thermal Resistance Junction-Case <sup>1</sup>	$R_{\theta JC}$	7.3	

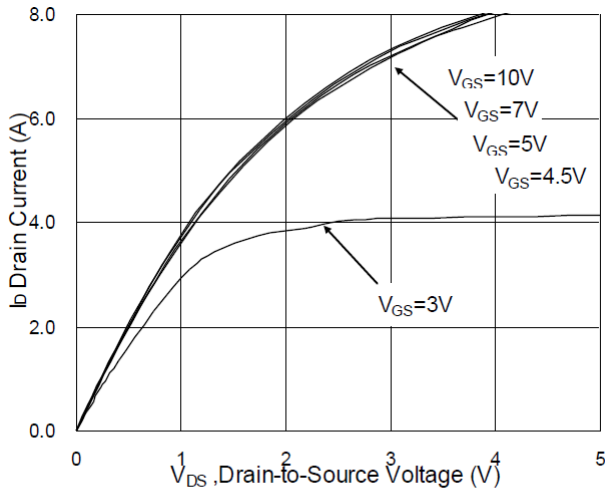
**ELECTRICAL CHARACTERISTICS** ( $T_J=25^\circ\text{C}$  unless otherwise specified)

Parameter	Symbol	Min.	Typ.	Max.	Unit	Test Conditions	
Drain-Source Breakdown Voltage	$BV_{DSS}$	100	-	-	V	$V_{GS}=0, I_D=250\mu\text{A}$	
Gate Threshold Voltage	$V_{GS(th)}$	1	-	2.5	V	$V_{DS}=V_{GS}, I_D=250\mu\text{A}$	
Forward Transfer Conductance	$g_{fs}$	-	2.4	-	S	$V_{DS}=5\text{V}, I_D=2\text{A}$	
Gate-Source Leakage Current	$I_{GSS}$	-	-	$\pm 100$	nA	$V_{GS}=\pm 20\text{V}$	
Drain-Source Leakage Current	$I_{DSS}$	$T_J=25^\circ\text{C}$	-	-	1	$\mu\text{A}$	$V_{DS}=80\text{V}, V_{GS}=0$
		$T_J=55^\circ\text{C}$	-	-	5		
Static Drain-Source On-Resistance <sup>4</sup>	$R_{DS(ON)}$	-	-	310	m $\Omega$	$V_{GS}=10\text{V}, I_D=2\text{A}$	
		-	-	320		$V_{GS}=4.5\text{V}, I_D=1\text{A}$	
Total Gate Charge	$Q_g$	-	9.3	-	nC	$I_D=2\text{A}$ $V_{DS}=50\text{V}$ $V_{GS}=10\text{V}$	
Gate-Source Charge	$Q_{gs}$	-	2	-			
Gate-Drain Charge	$Q_{gd}$	-	1.5	-			
Turn-on Delay Time	$T_{d(on)}$	-	2	-	nS	$V_{DD}=50\text{V}$ $I_D=2\text{A}$ $V_{GS}=10\text{V}$ $R_G=3.3\Omega$	
Rise Time	$T_r$	-	21.6	-			
Turn-off Delay Time	$T_{d(off)}$	-	11.2	-			
Fall Time	$T_f$	-	18.8	-			
Input Capacitance	$C_{iss}$	-	510	-	pF	$V_{GS}=0$ $V_{DS}=15\text{V}$ $f=1\text{MHz}$	
Output Capacitance	$C_{oss}$	-	30	-			
Reverse Transfer Capacitance	$C_{rss}$	-	16	-			
<b>Source-Drain Diode</b>							
Continuous Source Current <sup>1</sup>	$I_S$	-	-	5.5	A		
Pulsed Source Current <sup>3</sup>	$I_{SM}$	-	-	15			
Forward on Voltage <sup>4</sup>	$V_{SD}$	-	-	1.2	V	$I_S=1\text{A}, V_{GS}=0, T_J=25^\circ\text{C}$	

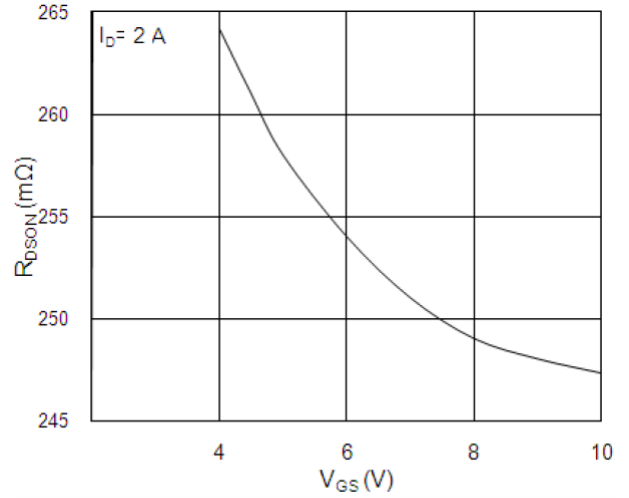
Notes:

- Surface mounted on a 1 inch<sup>2</sup> FR-4 board with 2oz copper.
- When mounted on Min. copper pad.
- Pulse width limited by maximum junction temperature, pulse width $\leq 300\mu\text{s}$ , duty cycle $\leq 2\%$ .
- Pulse Test: Pulse Width $\leq 300\mu\text{s}$ , Duty Cycle $\leq 2\%$ .

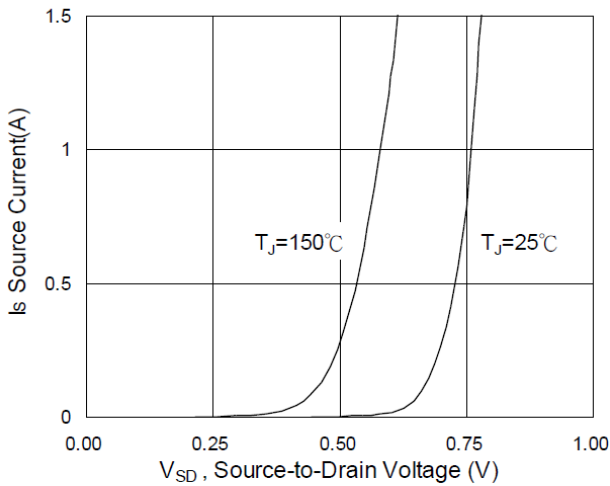
**CHARACTERISTIC CURVES**



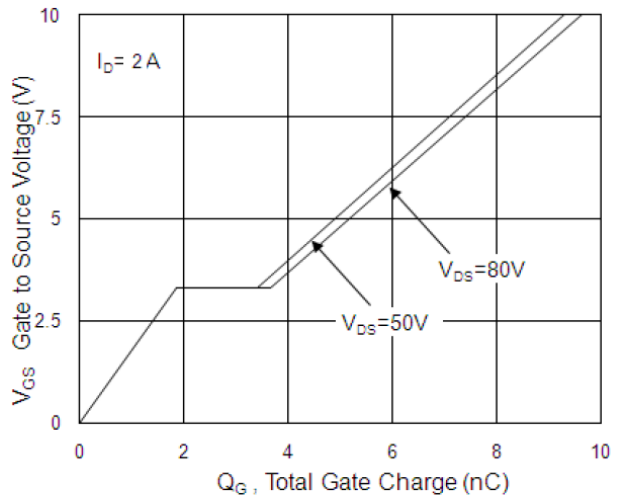
**Fig.1 Typical Output Characteristics**



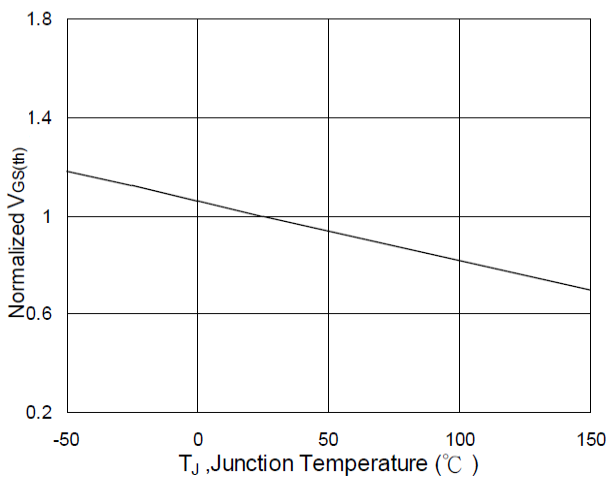
**Fig.2 On-Resistance vs. Gate-Source**



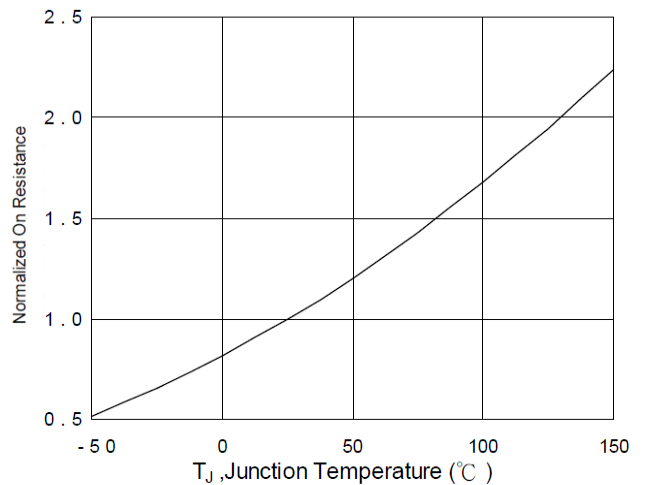
**Fig.3 Forward Characteristics Of Reverse**



**Fig.4 Gate-Charge Characteristics**

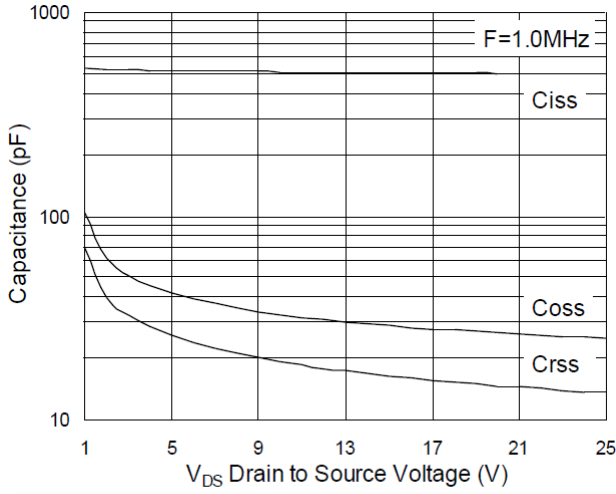


**Fig.5 Normalized  $V_{GS(th)}$  vs.  $T_J$**

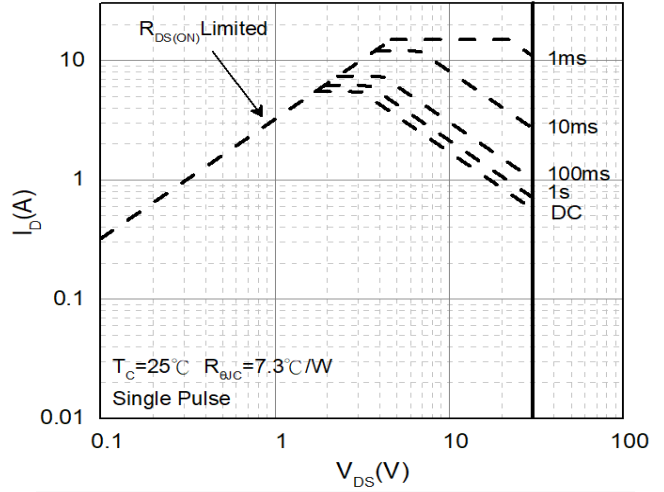


**Fig.6 Normalized  $R_{DS(on)}$  vs.  $T_J$**

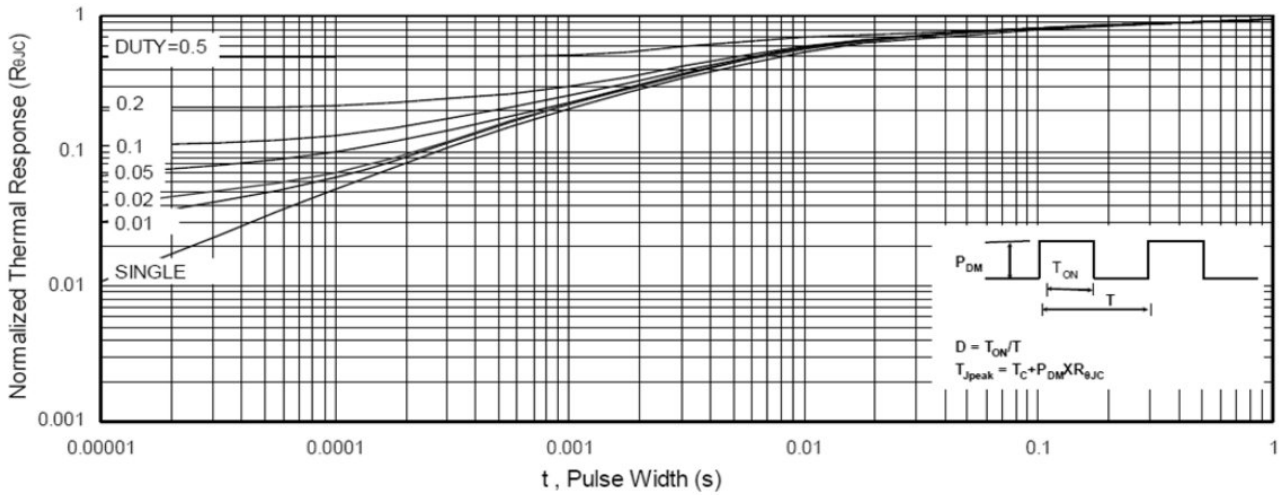
**CHARACTERISTIC CURVES**



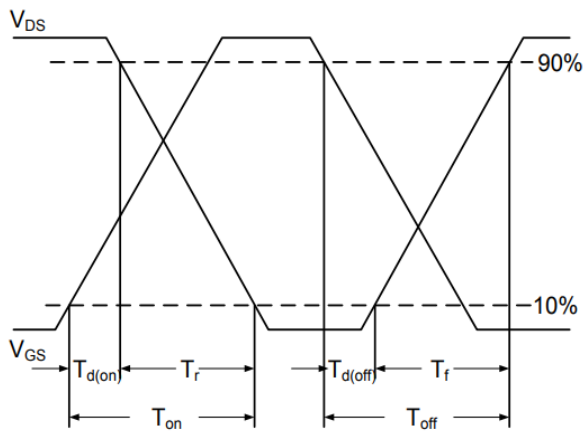
**Fig.7 Capacitance**



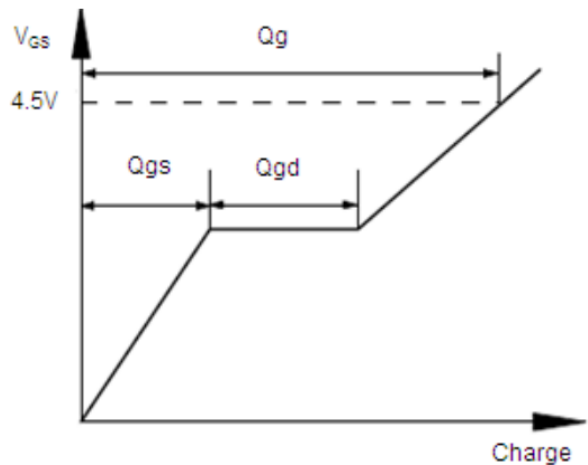
**Fig.8 Safe Operating Area**



**Fig.9 Normalized Maximum Transient Thermal Impedance**



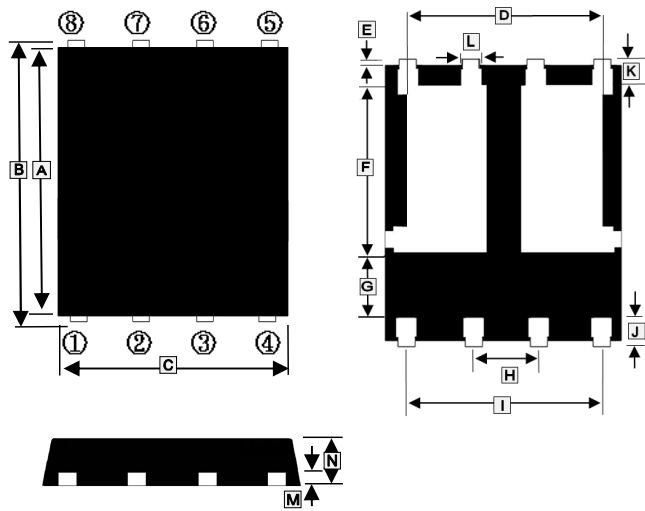
**Fig.10 Switching Time Waveform**



**Fig.11 Gate Charge Waveform**

**PACKAGE OUTLINE DIMENSIONS**

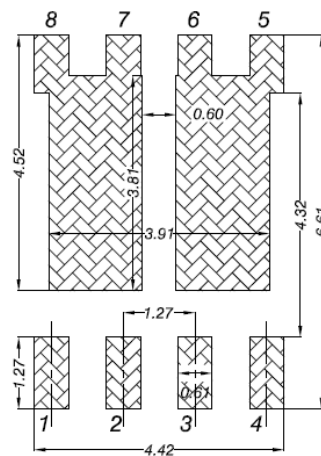
**DFN5x6-8D**



REF.	Millimeter	
	Min.	Max.
A	5.70	5.80
B	5.90	6.10
C	4.80	5.00
D	3.61	3.96
E	0.06	0.20
F	3.38	3.78
G	1.10	-
H	1.27 BSC.	
I	3.61	3.96
J	0.51	0.71
K	0.41	0.61
L	0.33	0.51
M	0.20	0.30
N	0.90	1.10

**MOUNTING PAD LAYOUT**

**DFN5x6-8D**



\*Dimensions in millimeters