

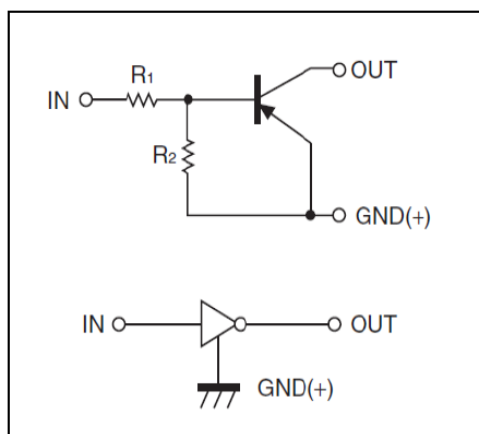

RoHS Compliant Product
A suffix of "-C" specifies halogen & lead-free

FEATURES

- Built-in bias resistors enable the configuration of an inverter circuit without connecting external input resistors (see equivalent circuit).
- The bias resistors consist of thin-film resistors with complete isolation to allow positive biasing of the input. They also have the advantage of almost completely eliminating parasitic effects.
- Only the on/off conditions need to be set for operation, making device design easy.

EQUIVALENT CIRCUIT

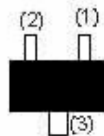

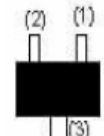
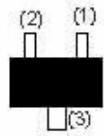
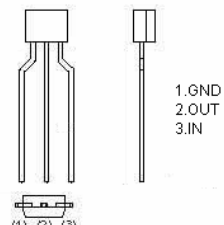
<p align="center">DTA143ZE (SOT-523)</p>  <p align="right">1.IN 2.GND 3.OUT</p> <p align="center">Abbreviated symbol : E13</p>	<p align="center">DTA143ZUA(SOT-323)</p>  <p align="right">1.IN 2.GND 3.OUT</p> <p align="center">Abbreviated symbol : 113</p>
<p align="center">DTA143ZM (SOT-723)</p>  <p align="right">1.IN 2.GND 3.OUT</p> <p align="center">Abbreviated symbol : E13</p>	<p align="center">DTA143ZCA (SOT-23)</p>  <p align="right">1.IN 2.GND 3.OUT</p> <p align="center">Abbreviated symbol : E13</p>
<p align="center">DTA143ZSA (TO-92S)</p>  <p align="right">1.GND 2.OUT 3.IN</p>	

ABSOLUTE MAXIMUM RATINGS (T_A=25°C unless otherwise noted)

Parameter	Symbol	Limits (DTA143Z□)					Unit
		M	E	UA	CA	SA	
Supply Voltage	V _{CC}			-50			V
Input voltage	V _{IN}			-30 ~ 5			V
Output current	I _O			-100			mA
Power dissipation	P _D	100	150	200		300	mW
Junction & Storage temperature	T _J , T _{STG}			150, -55~150			°C

ELECTRICAL CHARACTERISTICS ($T_A=25^\circ\text{C}$ unless otherwise noted)

Parameter	Symbol	Min.	Typ.	Max.	Unit	Test Conditions
Input voltage	$V_{I(off)}$	-0.5	-	-	V	$V_{CC} = -5\text{V}$, $I_O = -100\mu\text{A}$
	$V_{I(on)}$	-	-	-1.3		$V_O = -0.3\text{V}$, $I_O = -5\text{mA}$
Output voltage	$V_{O(on)}$	-	-	-0.3	V	$I_O/I_I = -5\text{mA}/-0.25\text{mA}$
Input current	I_I	-	-	-1.8	mA	$V_I = -5\text{V}$
Output current	$I_{O(off)}$	-	-	-0.5	μA	$V_{CC} = -50\text{V}$, $V_I = 0$
DC current gain	G_I	80	-	-		$V_O = -5\text{V}$, $I_O = -10\text{mA}$
Input resistance	R_1	3.29	4.7	6.11	K Ω	
Resistance ratio	R_2/R_1	8	10	12		
Transition frequency	f_T	-	250	-	MHz	$V_O = -10\text{V}$, $I_O = -5\text{mA}$, $f = 100\text{MHz}$

CHARACTERISTIC CURVES

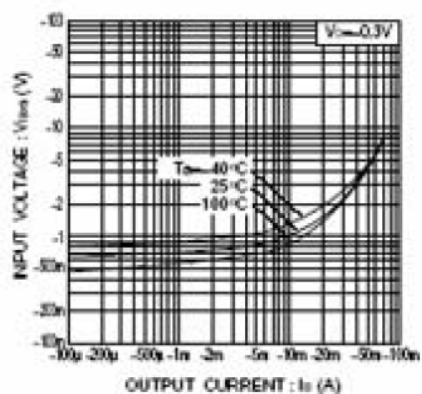

Fig.1 Input voltage vs. output current (ON characteristics)

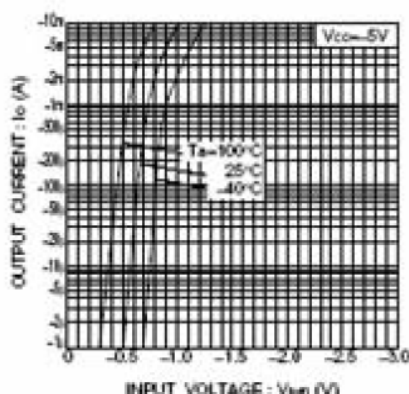

Fig.2 Output current vs. input voltage (OFF characteristics)

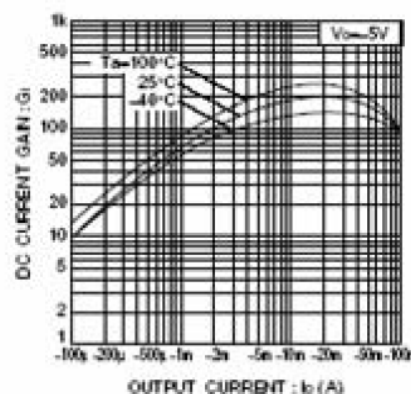

Fig.3 DC current gain vs. output current

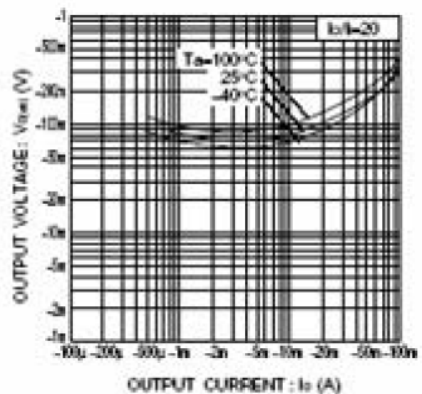

Fig.4 Output voltage vs. output current