

RoHS Compliant Product
A suffix of "-C" specifies halogen & lead-free

FEATURES

- Built-in bias resistors enable the configuration of an inverter circuit without connecting external input resistors (see equivalent circuit).
- The bias resistors consist of thin-film resistors with complete isolation to allow positive biasing of the input. They also have the advantage of almost completely eliminating parasitic effects.
- Only the on/off conditions need to be set for operation, making device design easy.

EQUIVALENT CIRCUIT

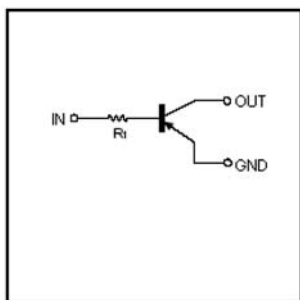

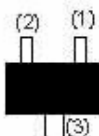
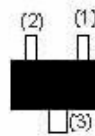
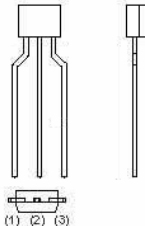
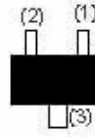
<p>DTA144TE (SOT-523)</p>  <p>1.IN 2.GND 3.OUT</p> <p>Abbreviated symbol : 96</p>	<p>DTA144TUA (SOT-323)</p>  <p>1.IN 2.GND 3.OUT</p> <p>Abbreviated symbol : 96</p>
<p>DTA144TSA (TO-92S)</p>  <p>1.GND 2.OUT 3.IN</p> <p>Abbreviated symbol : 96</p>	<p>DTA144TCA (SOT-23)</p>  <p>1.IN 2.GND 3.OUT</p> <p>Abbreviated symbol : 96</p>

ABSOLUTE MAXIMUM RATINGS at ($T_A = 25^\circ\text{C}$ unless otherwise noted)

Parameter	Symbol	Ratings				Unit
		E	UA	CA	SA	
Collector-Base Voltage	V_{CBO}	-50				V
Collector-Emitter Voltage	V_{CEO}	-50				V
Emitter-Base Voltage	V_{EBO}	-5				mA
Collector Current-Continuous	I_C	-100				
Collector Dissipation	P_C	150	200	300	mW	
Junction & Storage temperature	T_J, T_{STG}	150, -55~150				$^\circ\text{C}$

ELECTRICAL CHARACTERISTICS at ($T_A = 25^\circ\text{C}$ unless otherwise noted)

Parameter	Symbol	Min.	Typ.	Max.	Unit	Test Conditions
Collector-base breakdown voltage	$V_{(BR)CBO}$	-50	-	-	V	$I_C = -50\mu\text{A}, I_E = 0$
Collector-emitter breakdown voltage	$V_{(BR)CEO}$	-50	-	-		$I_C = -1\text{mA}, I_B = 0$
Emitter-base breakdown voltage	$V_{(BR)EBO}$	-5	-	-	V	$I_E = -50\mu\text{A}, I_C = 0$
Collector cut-off current	I_{CBO}	-	-	-0.5	μA	$V_{CB} = -50\text{V}, I_E = 0$
Emitter cut-off current	I_{EBO}	-	-	-0.5	μA	$V_{EB} = -4\text{V}, I_C = 0$
DC current gain	h_{FE}	100	300	600		$V_{CE} = -5\text{V}, I_C = -1\text{mA}$
Collector-emitter saturation voltage	$V_{CE(sat)}$	-	-	-0.3	V	$I_C = -5\text{mA}, I_B = -0.5\text{mA}$
Transition frequency	f_T	-	250	-	MHz	$V_{CE} = -10\text{V}, I_C = -5\text{mA}, f = 100\text{MHz}$
Input resistor	R1	32.9	47	61.1	k Ω	

CHARACTERISTIC CURVES

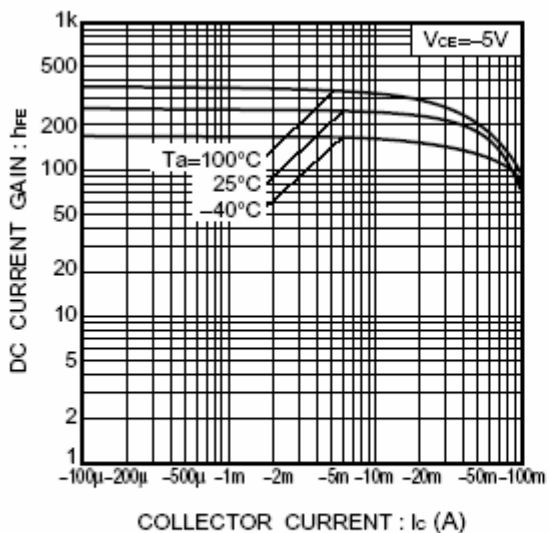

Fig.1 DC current gain vs. collector current

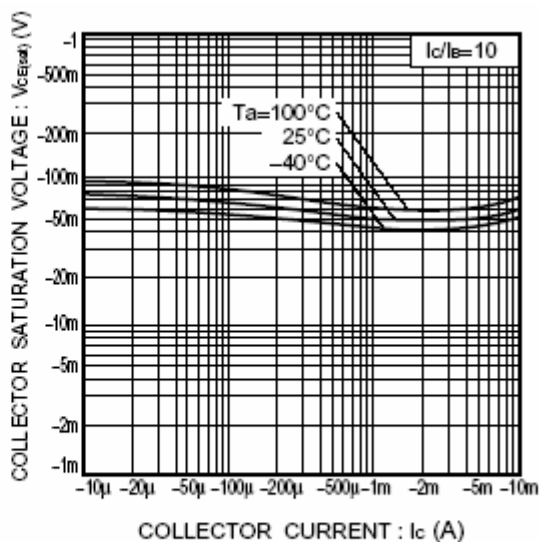

Fig.2 Collector-emitter saturation voltage vs. collector current